

NeoVision24 RGBW

24VDC 4.3W Side and TopFlex LED Tape Specification Sheet



Project Name	Type
--------------	------

Catalog #	Date
-----------	------

PRODUCT OVERVIEW

A 24VDC RGBW, flexible linear 'neon' tape that is field cuttable. Designed for applications that requires a neon-like ultra-rich, saturated color with 3500K white. SideFlex enables horizontal bending and TopFlex enables vertical bending that conforms tape around curvilinear surfaces



FEATURES

- 24VDC operation
- RGB with 3500K white
- Wet location - IP65
- Tape encased in UV stable silicone (UV protected)
- Wireless control with LUXcontrol App and controller
- Controllable with handheld remote
- Dimmable
- 120° viewing angle
- Maximum run: 16'-4"
- Cut and cap only in 2.5 inch increments while retaining IP65
- Mounting clips included (recommend use 1 per foot)
- Comes with power feed on each end (2 runs per reel, end cap included)

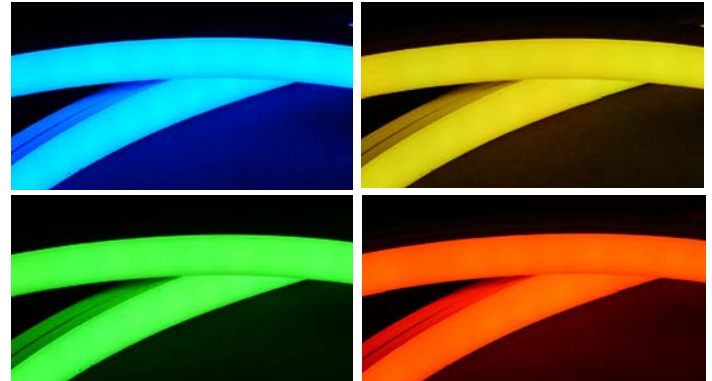

SPECIFICATIONS

ELECTRICAL

- 24VDC
- 4.3 watts per foot

OPTICS

- 90+ CRI

WARRANTY

- 5-year warranty when paired with GM power supply

CERTIFICATION

- 24VDC UL compliant
- IP65

ACCESSORIES

- LineDRIVE 24V Non-Dimming Power Supplies
- Aluminum Channels (below)
- Tape Cutting Tool (below)

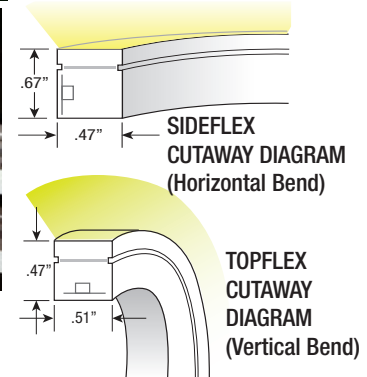

ORDERING INFORMATION

Example: NV24S-4W-RGBW-16

	-		-		-	
--	---	--	---	--	---	--

Model	-	Watts / Foot	-	Color	-	Reel Length
NV24S		4W		RGBW		16 (16'-4")
NV24T						

Each reel includes 48" leads. 16' reel includes (16) NV24T-MC-A mounting clips and screws. Operating temp.: -4° - 130°F.

CONTROLLERS

Model	Description
SHWC-RGBW	LUXcontrol Smart 2.4 GHz WiFi Controller, Standard 12V/24V Low Voltage, RGBW, 4-Channel / 5-Wire
SHWC-RGBW-RPT	LUXcontrol Universal Smart Power Repeater

RGBW SIDEFLEX ACCESSORIES

Catalog No.	Description
NV24S-CHL-A4	Aluminum channel - 4 ft. length
NV24S-CHL-A8	Aluminum channel - 8 ft. length
NV24S-FLEX-CHL	Flexible mounting channel - 39.5"
NV24S-MC-A	Aluminum mounting clip (set of 20)
NV24-CT	Tape cutting tool (works for both TopFlex and SideFlex)
NV24S-EC	End cap

RGBW TOPFLEX ACCESSORIES

Catalog No.	Description
NV24T-CHL-A4	Aluminum channel - 4 ft. length
NV24T-CHL-A8	Aluminum channel - 8 ft. length
NV24T-FLEX-CHL	Flexible mounting channel - 39.5"
NV24T-MC-A	Aluminum mounting clip (set of 20)
NV24-CT	Tape cutting tool (works for both TopFlex and SideFlex)
NV24T-EC	End cap

The above connectors, channels, mounting clips and caps are for the exclusive use of NeoVision24 SideFlex RGBW Neon Tape. See website for accessory images.

The above connectors, channels, mounting clips and caps are for the exclusive use of NeoVision24 RGBW TopFlex Neon Tape. See website for accessory images.



NeoVision24 RGBW

24VDC 4.3W Side and TopFlex LED Tape Specification Sheet



Catalog No.	Length	Wattage	CRI	White Color Temp.	Max. Run
NV24S-4W-RGBW-16	16'-4"	4.3W / FT.	90+	3500K	16'-4"
NV24T-4W-RGBW-16	16'-4"	4.3W / FT.	90+	3500K	16'-4"

Kelvin temperature (color) ±100K.

Every reel includes (1) NV24T-PF-EF (tape to power feed with 48" of lead. 16' reel includes (16) NV24T-MC-A mounting clips and screws. Operating temp.: -4° - 130°F.

CONTROLLER AND REPEATER

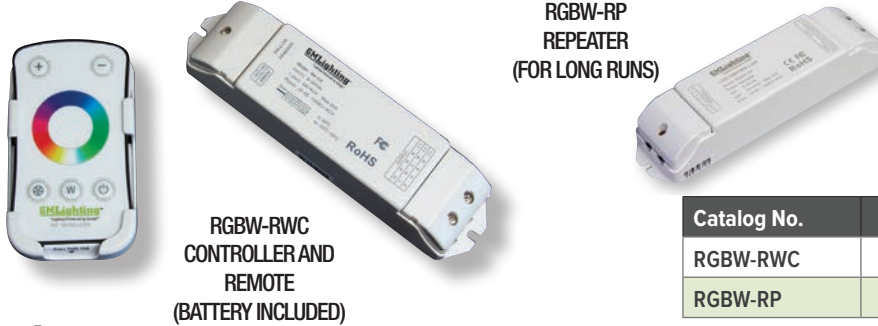

**RGBW-RWC
CONTROLLER AND
REMOTE
(BATTERY INCLUDED)**

**RGBW-RP
REPEATER
(FOR LONG RUNS)**

Catalog No.	Description
RGBW-RWC	Controller and remote with battery
RGBW-RP	Repeater

NOTE: USE WITH LineDRIVE™ NON-DIM POWER SUPPLIES (LD-E SERIES)

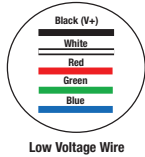
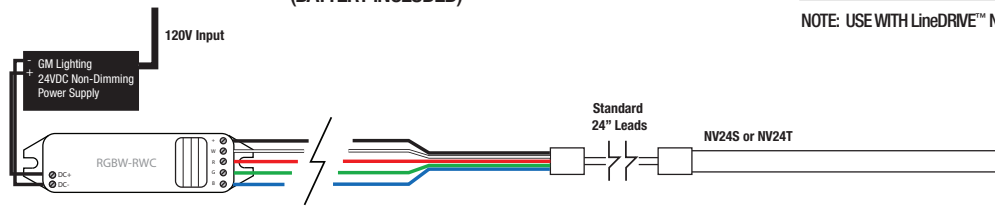

DIMENSIONS

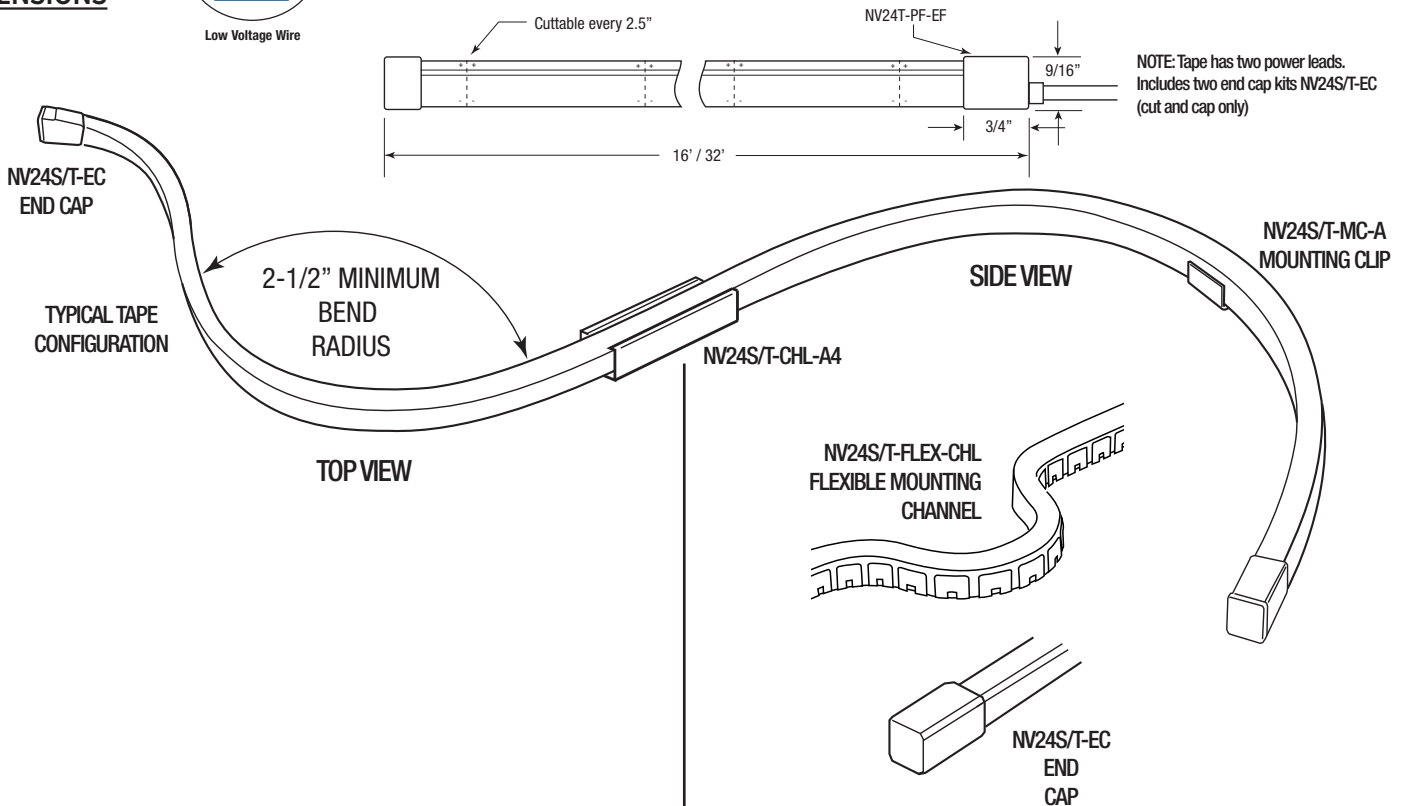

NeoVision24 RGBW

24VDC 4.3W Side and TopFlex LED Tape Specification Sheet



WIRING DIAGRAM - LUXCONTROL WIFI CONTROLLER

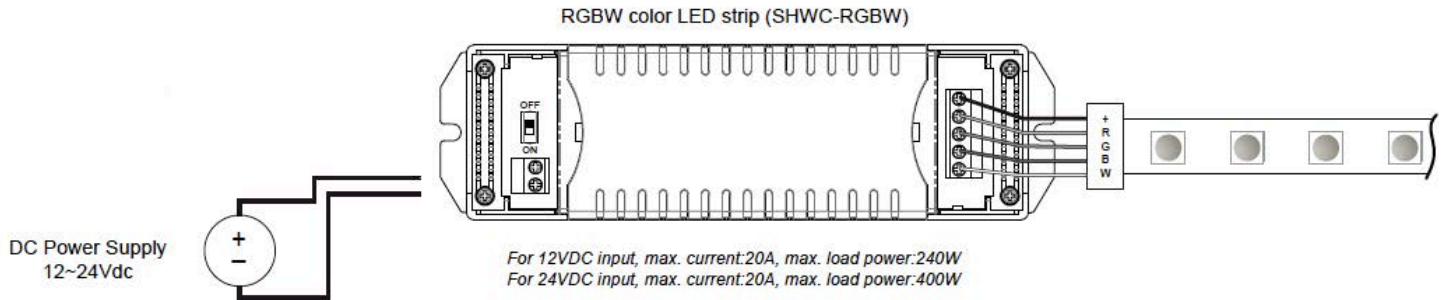

SHWC-RGBW and Repeater Wiring

RGBW connection (4 channels)

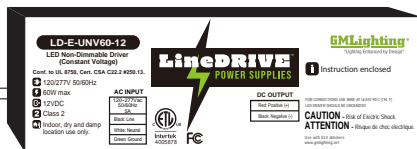
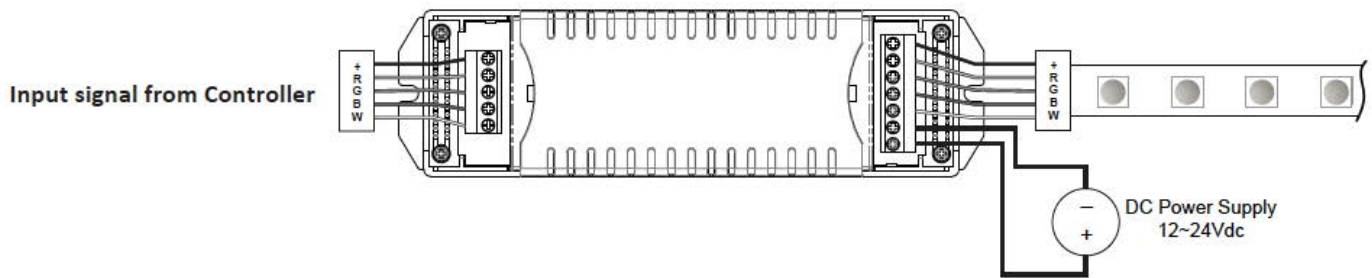

LineDRIVE™ Power Supply

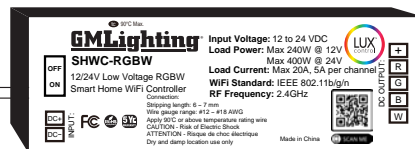

LUXcontrol™ Controller

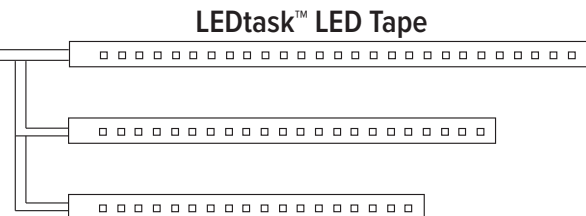

Expandable with universal power repeater (SHWC-RGBW-RPT) for larger projects



Remote WiFi Control

LUXcontrol™ App



Router Signal